

MODEL:

OBS2

800×800×1850

900×900×1850

TYP VÝROBKU / TYPE OF PRODUCT:

čtvrtkruhový sprchový kout se dvěma posuvnými dveřmi
štvrtkruhový sprchovací kút s dvoma posuvnými dverami
quadrant shower enclosure with two sliding doors



outlet.roltechnik.cz

ROLTECHNIK s.r.o. / Třebařov 160 / 569 33 / Czech Republic



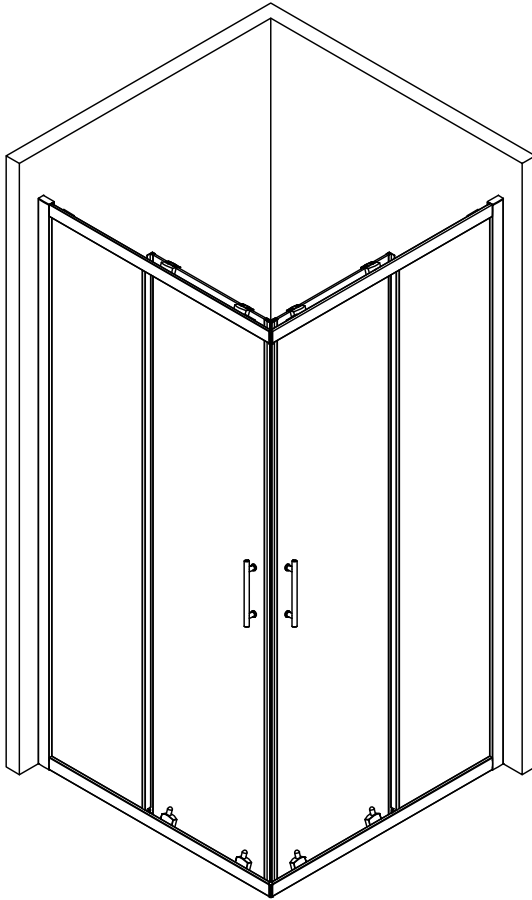

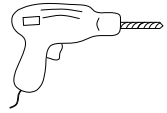
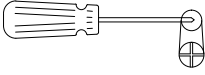
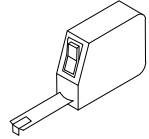
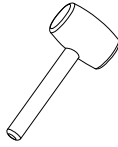
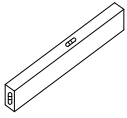



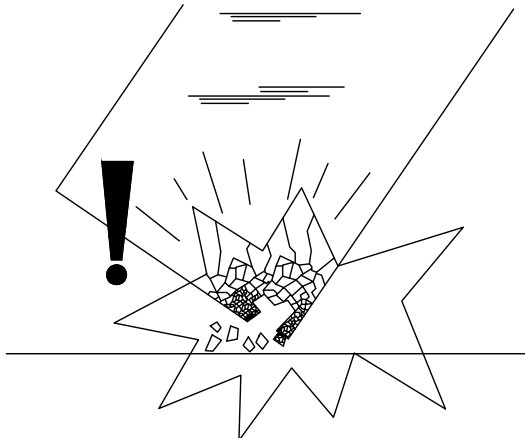
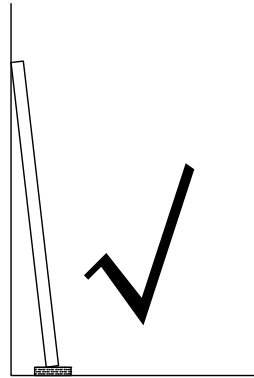
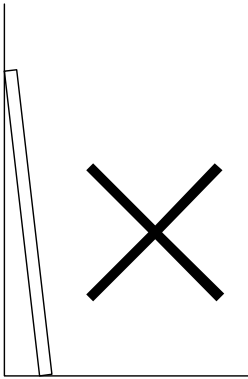
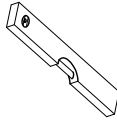



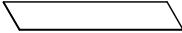

OBS 2



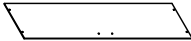



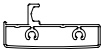





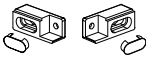

Ø6 Ø2.8



serial number	graphical	name	quantity	remarks
1			6 PCS	
2		ST3. 9X35	6 PCS	
3			2 PCS	
4			2 PCS	
5			6 PCS	
6		ST3. 5X9. 5	6 PCS	
7			2 PCS	
8			2 PCS	
9			2 PCS	
10			4 PCS	
11		ST3. 5X35	8 PCS	
12			8 PCS	
13			2 PCS	
14			2 PCS	
15			2 PCS	
16			2 PCS	

serial number	graphical	name	quantity	remarks
17			4 PCS	
18			2 PCS	
19		ST3. 5X6. 5	4 PCS	
20		ST3. 5X13	4 PCS	
21			2 PCS	
22			1 PCS	
23		ST3. 5X9. 5	8 PCS	
24			2 PCS	
25			2 PCS	
26			2 PCS	
27		$\phi 2.8$	1 PCS	

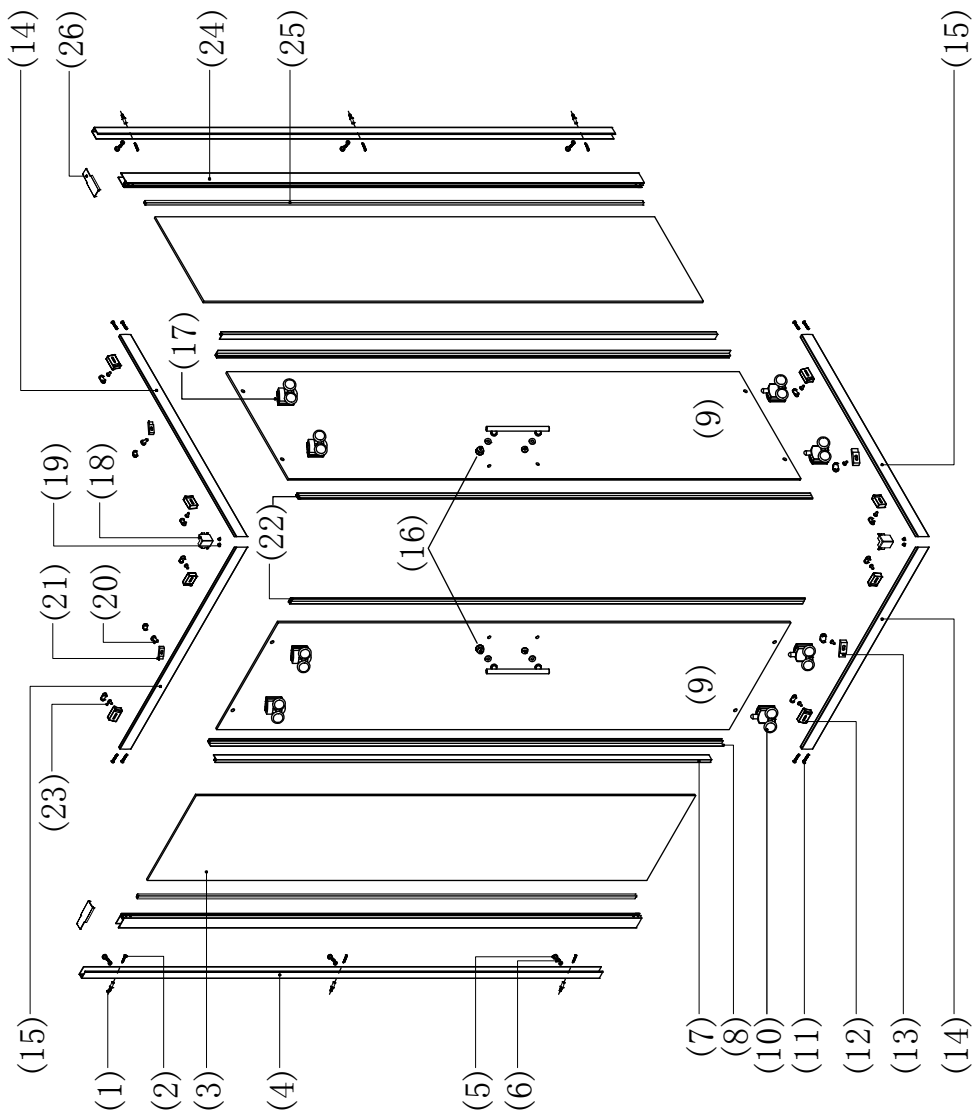

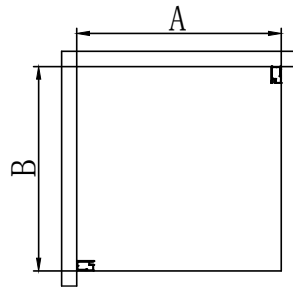
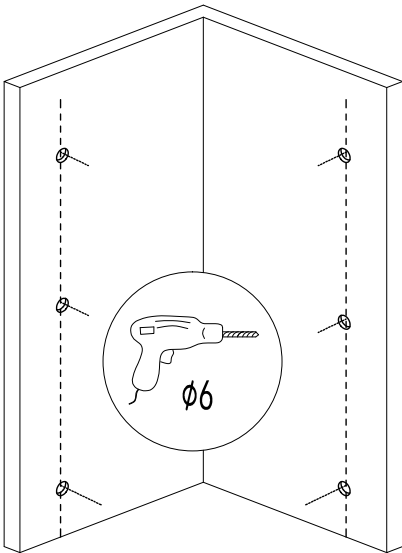
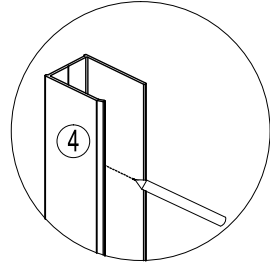
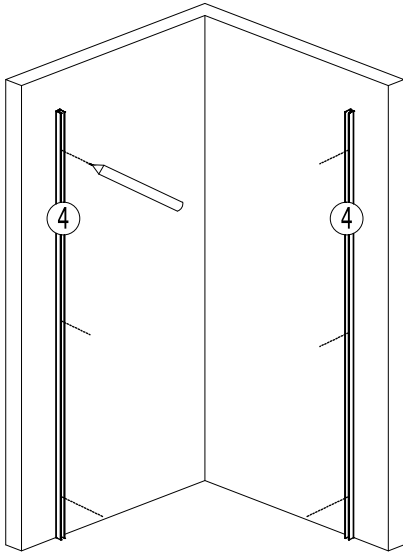

Size (mm)	A (mm)	B (mm)
800*1000	775-790	975-990
900*900	875-890	875-890

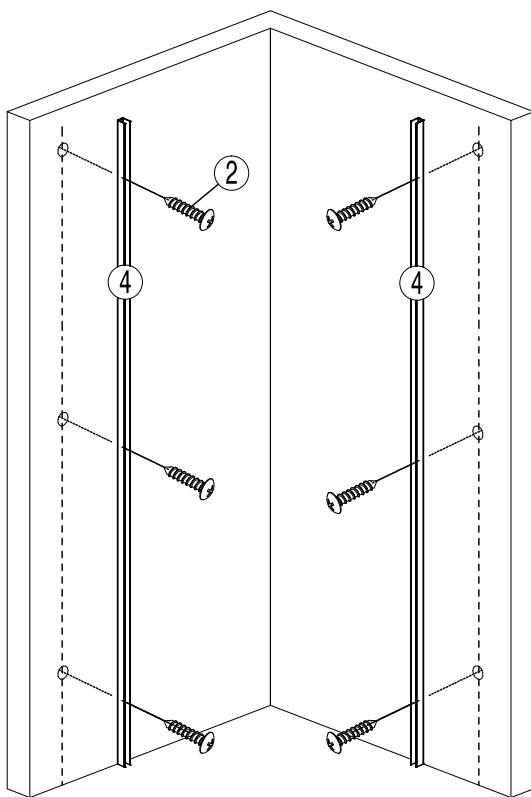
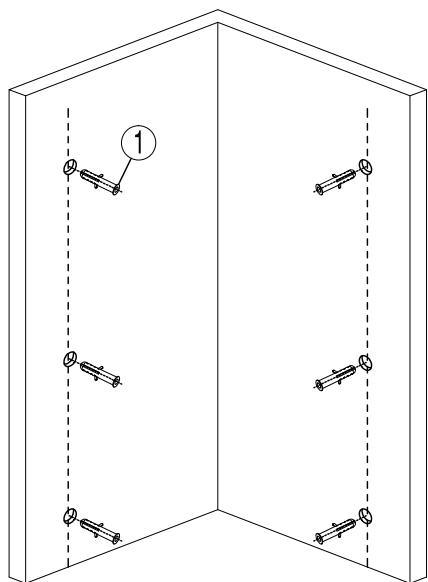

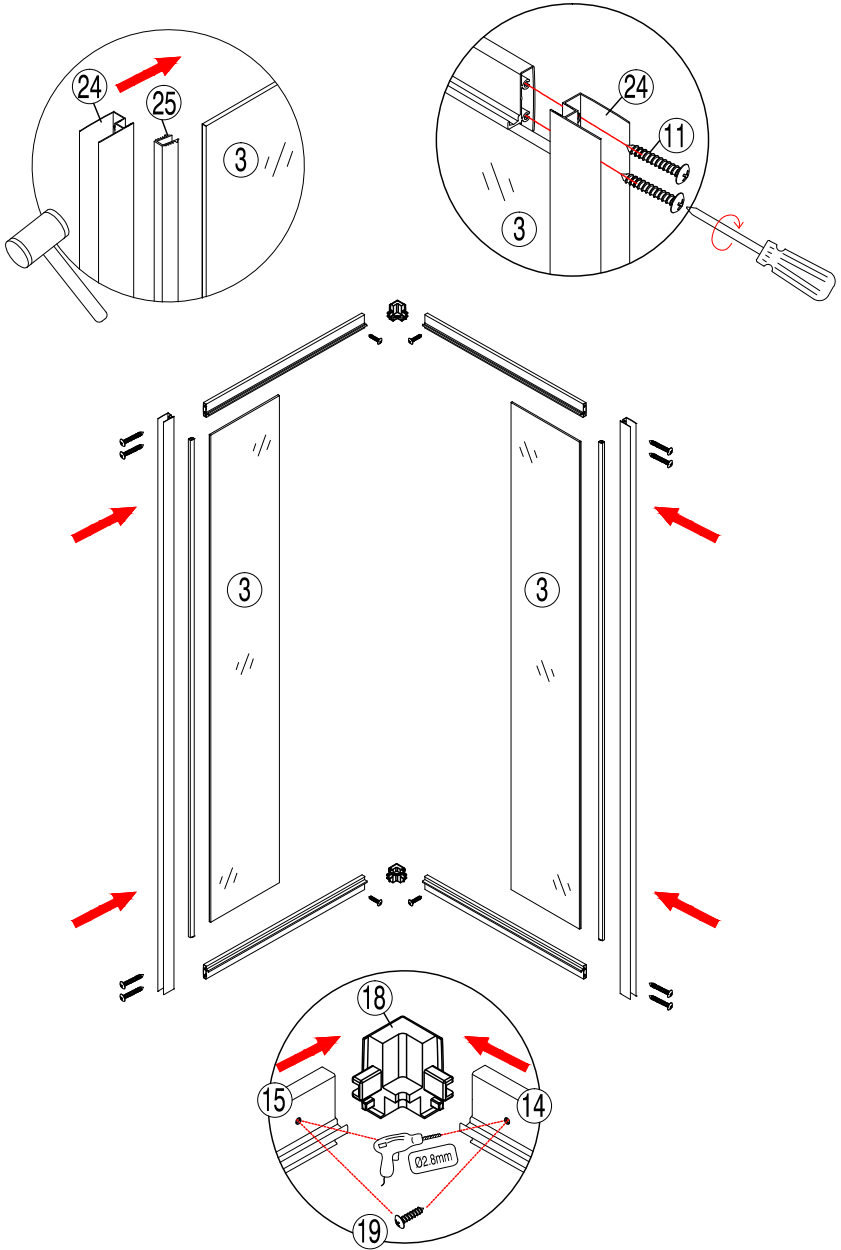

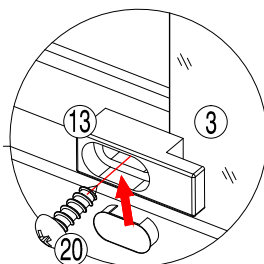
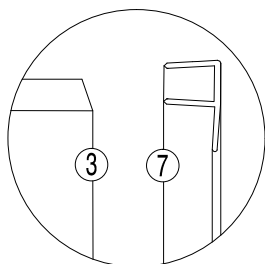
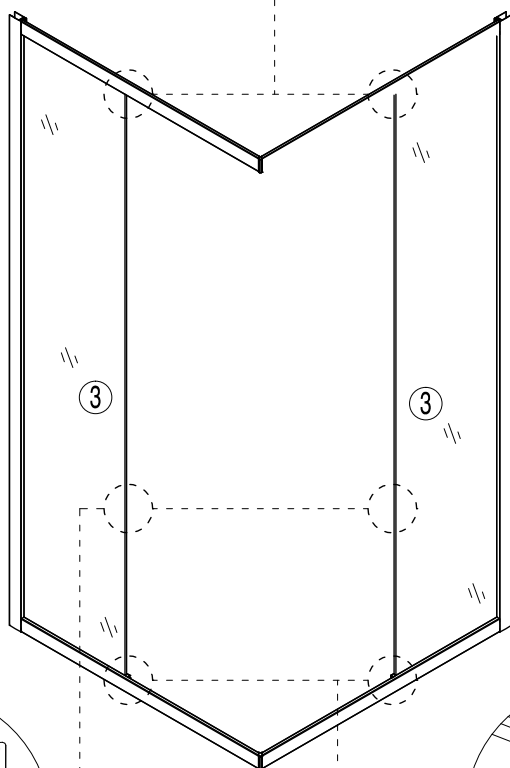
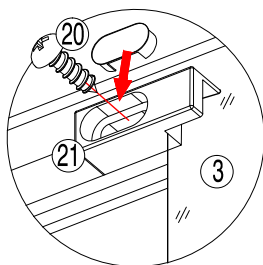

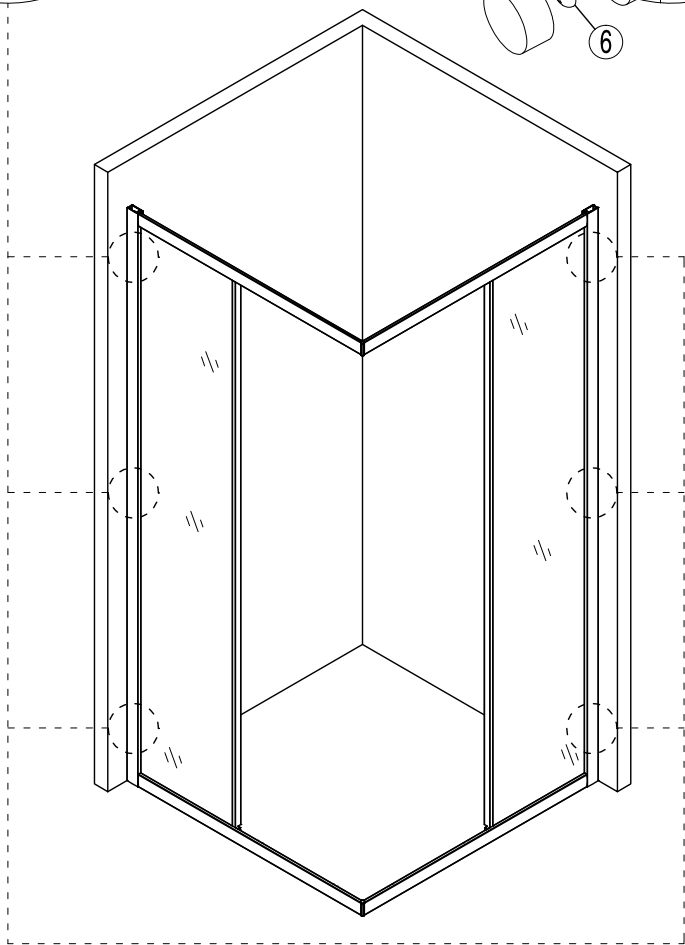
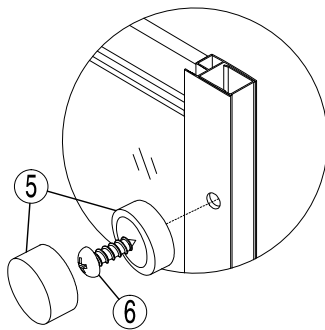
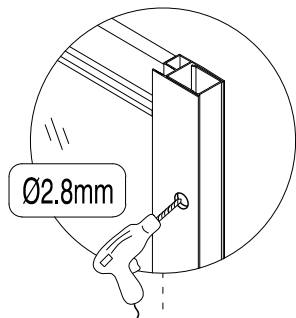

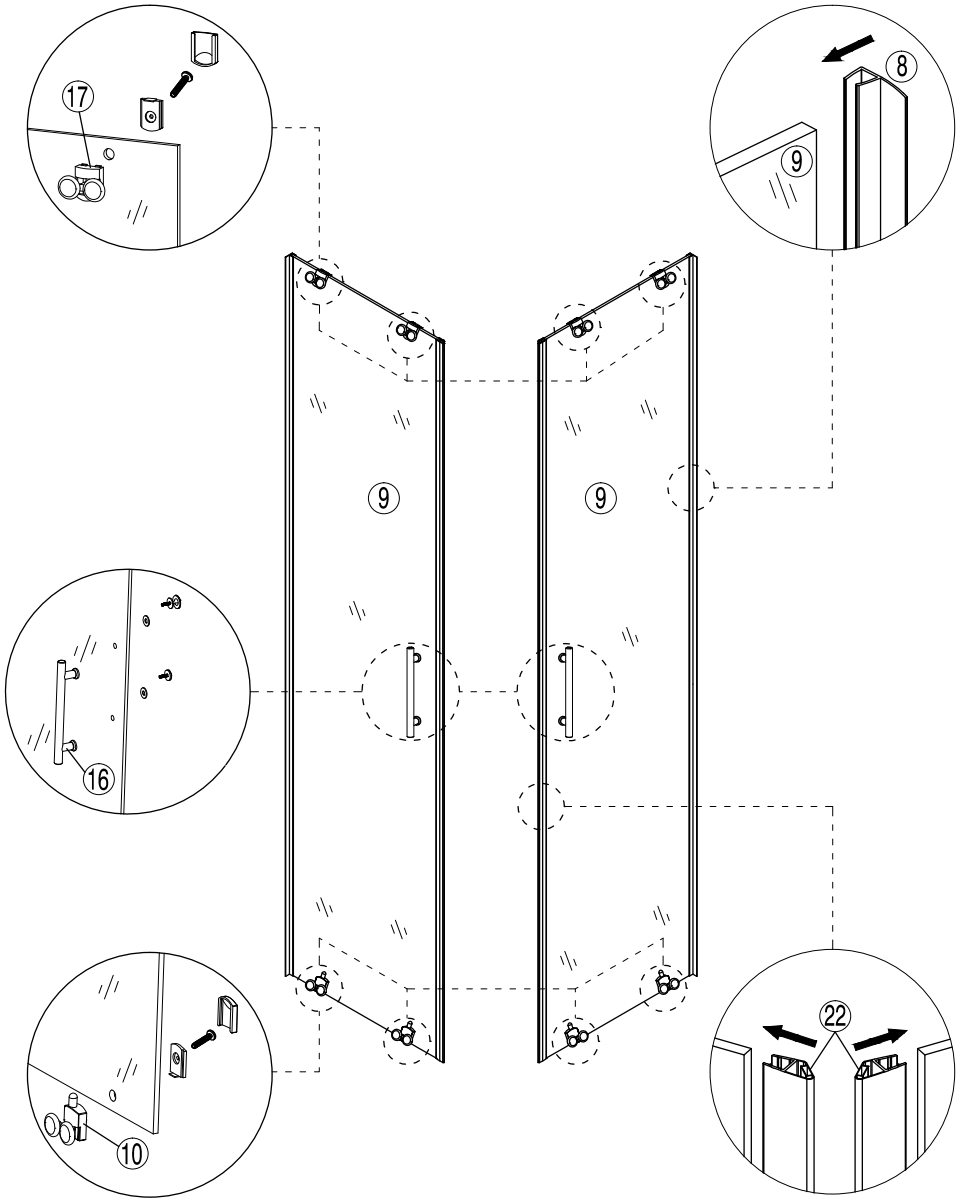

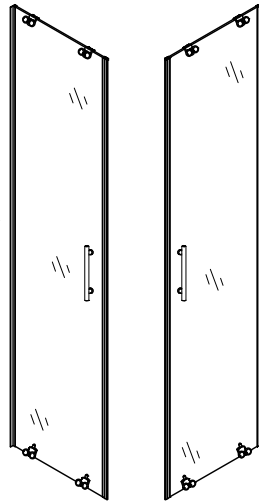
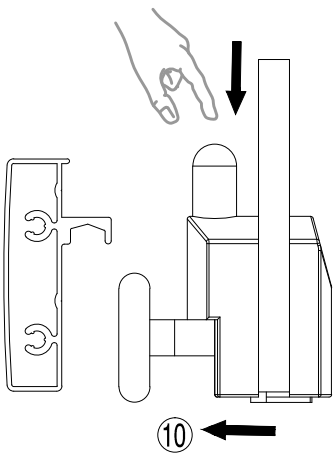
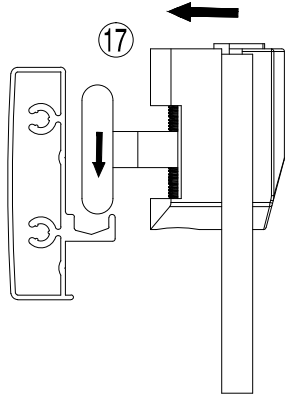
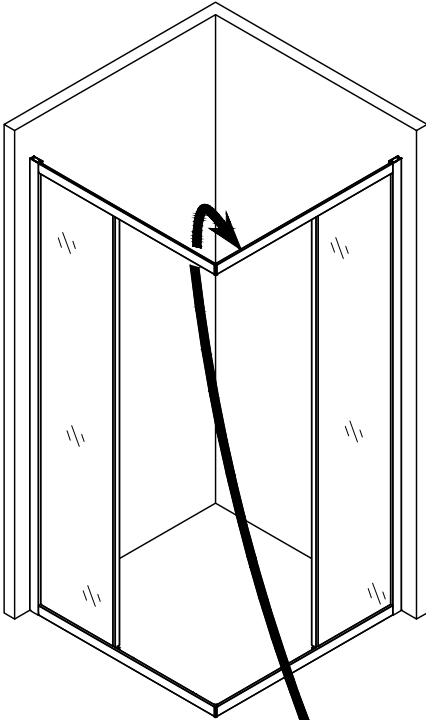

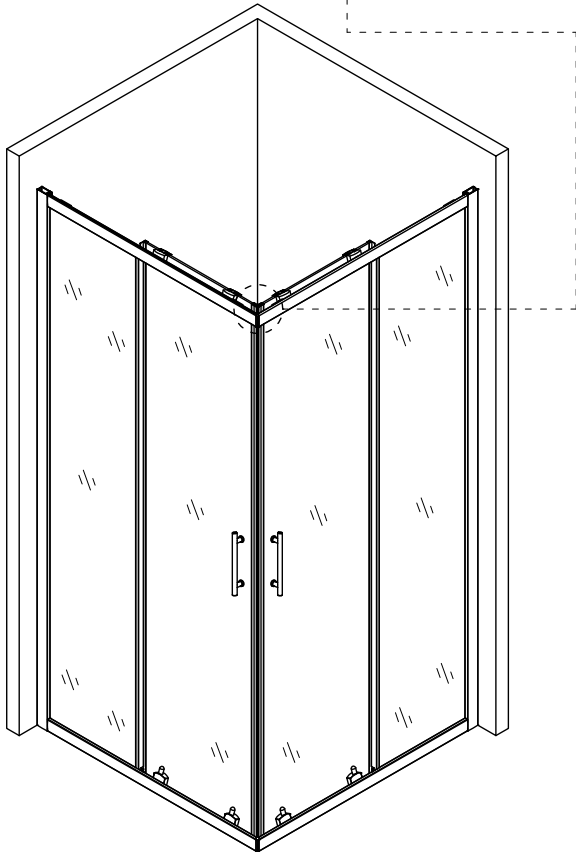
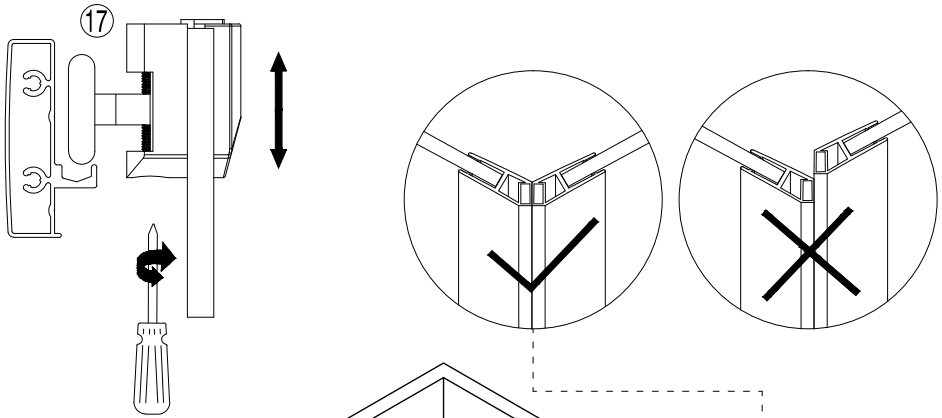

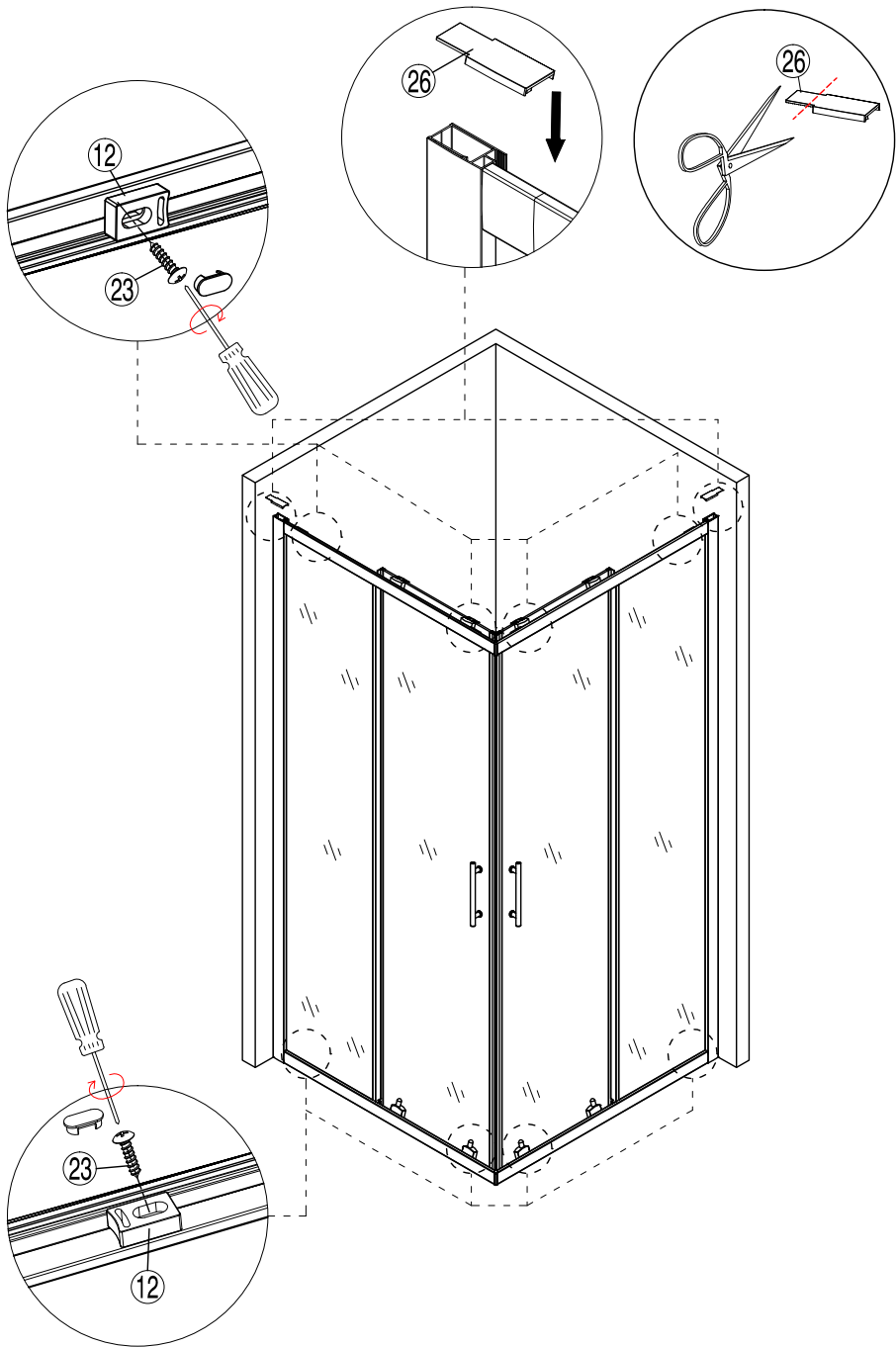

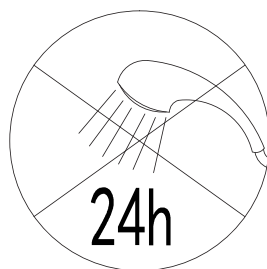
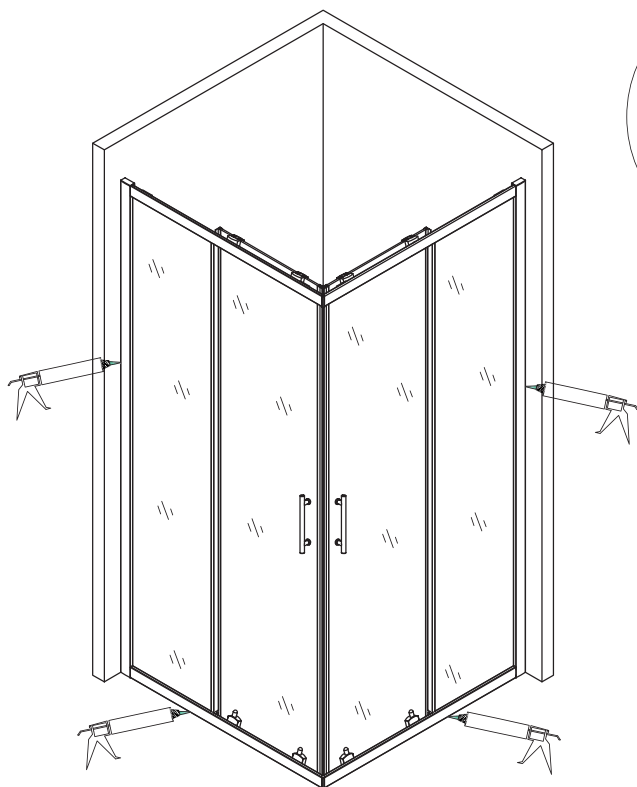

**ISANITA**

outlet.roltechnik.cz

ROLTECHNIK s.r.o. / Třebařov 160 / 569 33 / Czech Republic
tel.: +420 461 324 301 / fax: +420 461 324 297

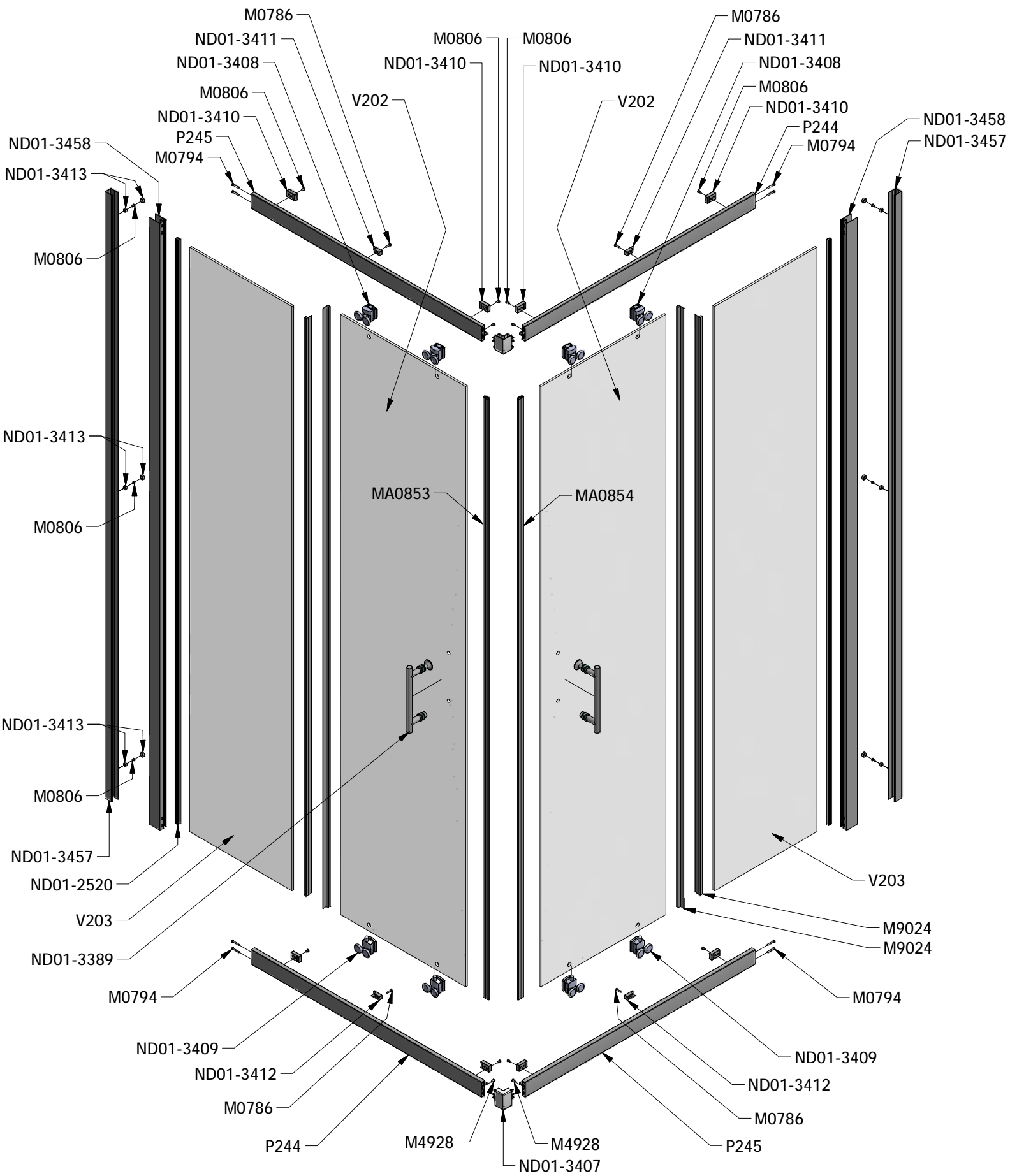

V202	800	brillant/transparent	MA6867
	900		MA6868
V203	800	brillant/transparent	MA6866
	900		MA6548
P244	800	brillant	ND01-3461
	900		ND01-3459
P245	800	brillant	ND01-3462
	900		ND01-3460

